

AUDIUM *Air Wireless*

User Manual



Thank you very much for your trust in AUDIUM products.

This AUDIUM Air Wireless system is the next step into modern music reproduction. It is not just a pair of wireless speakers, you have a complete audiophile stereo system capable of wireless audio playback and connectivity to many kind of digital audio sources.

Please read this manual in advance before setting up your loudspeakers. It will give you all necessary information and tips to achieve the best setup and thus, the maximum fidelity in audio reproduction with your AUDIUM Air speakers.

Thank you very much,
Your AUDIUM Team!

You will find enclosed:

- 1x Air Master Speaker
- 1x Air Slave Speaker
- 2x WiFi Antennas
- 1x Coaxial Digital Cable (Comp 7, 8 and 9)
- 2x Power Supply incl. Power Cord
- 1x User manual
- 8x Spikes (M8 winding thread)

Contents

Contents	4
General Information	6
<i>Warranty</i>	6
<i>Warning - Safety Instructions</i>	6
<i>Burn-In of the Loudspeakers:</i>	6
<i>Handling, Cleaning and Care</i>	6
<i>Terminology</i>	6
Unpacking the speakers	7
<i>Spikes:</i>	7
<i>Dust-Caps:</i>	7
<i>Foam-Plugs in the bass reflex tube:</i>	7
Speaker Placement	8
<i>Listening Position</i>	8
<i>Position in your listening room</i>	8
<i>Angling</i>	8
Controls and Connectors	9
<i>Power Supply (PSU)</i>	9
<i>Display showing current speaker Status</i>	10
<i>Muting and Locking the Loudspeaker</i>	10
Muting the speakers	10
Locking the speakers	10
<i>Auto Power On and Off</i>	11
<i>The Setup Menu</i>	11
<i>Air Wireless Speaker Pairs</i>	11
Basic Setup and connecting the Loudspeakers	12
<i>Master and Slave:</i>	12
<i>Wireless Link or CableLink?</i>	12
Powering Up and Booting the Speakers	12
Operating Scenarios of your Air's	13
<i>Scenario 1: As Wifi Loudspeaker in your Home WLAN</i>	13
Connecting the Speakers to your WLAN via the App	13
Connecting the Speaker to your WLAN via WPS	14
<i>Scenario 2: As WiFi Loudspeaker to play back music through the Digital Inputs</i>	15
Volume Adjustment:	15
<i>Scenario 3: As Bluetooth Loudspeaker for your Smart TV</i>	16
Active Inputs + Input Monitor:	17
<i>Changing the Input Priority</i>	17

Advanced Speaker Setup and Adjustments	18
<i>Speaker Position:</i>	<i>18</i>
<i>Room Properties:</i>	<i>18</i>
<i>Bass Setting:</i>	<i>18</i>
Appendix 1: Main Setup Menu	19
<i>Air Setup Menu (at Master Loudspeaker)</i>	<i>20</i>
<i>Air Setup Menu (at Slave Loudspeaker)</i>	<i>21</i>
<i>Gain Menu (only at Master Loudspeaker)</i>	<i>21</i>
<i>EQ menu</i>	<i>22</i>
Appendix 2: Hints for setting up your WiFi	23
Appendix 3: Glossary	24
Appendix 4: Questions and Answers	25
Appendix 5: Technical Data	26
Appendix 6: Disclaimer	27
<i>E.C. MARKING:</i>	<i>27</i>
<i>Proper Disposal of Products</i>	<i>27</i>

General Information

Warranty

For being independent of your regional dealer/distributor we strictly recommend to use our international warranty registration. So please visit www.audium.com/registration to register your Loudspeakers. Within your registration we are offering you an international worldwide warranty under the regulations of AUDIUM.

Warning - Safety Instructions

1. Read and follow all instructions in this manual. Keep this manual for later reference.
2. Do not use this products on humid places or near water.
3. They are intended for indoor-use. Do not use outside of buildings!
4. Do not use this products near heat sources. E.g. radiators, stoves, amplifiers or any other device that produces heat. Do not block any heat sinks or ventilation openings.
5. Unplug the speakers from the main outlets during lightning storms or when unused for long periods of time.
6. In case of damage or malfunction do not try to repair the speakers on your own. Always contact your dealer, or authorized service personal to service the products.

WARNING RISK OF ELECTRIC SHOCK! DO NOT OPEN!

To reduce the risk of electric shock, do not open the power supplies and do not expose the apparatus to rain or moisture. There are no user serviceable parts inside.

Burn-In of the Loudspeakers:

Loudspeakers are equipped with moveable parts. Thus they require a specific "burn-in time" until these parts can move in their required tolerance range. After this period, the loudspeakers can develop their full acoustic potentials.

For the burn-in of your new AUDIUM loudspeakers, you should play back music signals with a very broad frequency spectrum for min. 2 days. Preferably you can use a special Burn-In CD (containing pink noise signal).

Please note that after a long period of inactivity of your speakers the moveable parts get back to their initial rigid state. So please give them a few hours time for "warm-up" again through playing music, and you will notice the distinct increase of fidelity within this time.

Handling, Cleaning and Care

For cleaning, use a soft dry or slightly damp cloth.

Please avoid aggressive cleaning agents as well as special furniture polishes or any other cleaning fluids. Dust from the chassis can be removed gently by using a tiny furniture brush.

Warning: Avoid touching the chassis and membranes!

They are very sensitive and can be easily damaged!

Terminology

Your Mobile device (iPhone, iPad, Android phone or Android tablet) or your Laptop or PC (with WiFi card) will be called „Audio Source“. Your AUDIUM Air loudspeakers will be called „Airs“. „Master“ is the speaker with the WiFi receiver and the digital inputs showing AirM in the Display, „Slave“ is the other speaker showing AirS in the Display.

Functions only available at Comp 7-9 are printed in blue colour.

Unpacking the speakers

Your AUDIUM speakers are delivered in separate cartons. After opening them, remove the polyfoam protection elements and the textile bag. Do not dispose the packaging - you can carry the speakers in a save way only when using the original packaging.

Spikes:

AUDIUM floor speakers radiate sound best when the front baffle is inclined for a few degrees. Therefore screw the front spikes for 5mm, the rear spikes completely into the designated winding-drills. Take care that the speaker has a steady position.

Finally, tighten the spikes with the appropriate screw nuts.

You find further information on the setup below in the chapter "Installation".

Note: To protect wooden floors, we recommend the use of washers, which you can get from your dealer. Alternatively, you can also use any metal discs for bridging.

Dust-Caps:

The loudspeakers are equipped with dust-caps per default. These are simply attached to the speaker front and can be removed with low force through pulling them off, as we recommend. Even though these dust-caps have been designed according to acoustic aspects, the best sound performance can be achieved when they are removed from the loudspeakers.

Foam-Plugs in the bass reflex tube:

The bass reflex tubes are sealed with a semi-permeable foam stopper. **DO NOT** remove this to change the bass response. The tuning of the speakers is chosen by us in a way that you achieve the maximum tonal performance **WITH** these plugs. If you want to boost bass, you can do so by using the Bass setting in the Speaker Setup.



Speaker Placement

Listening Position

As shown in the illustration to the right, the two speakers and your listening position ideally form an equal-sided triangle with the edge lengths A and B. The distance A between the Speakers should be smaller than the distance B between the speakers and yours listening position. Distance A should be min. 2 meters.

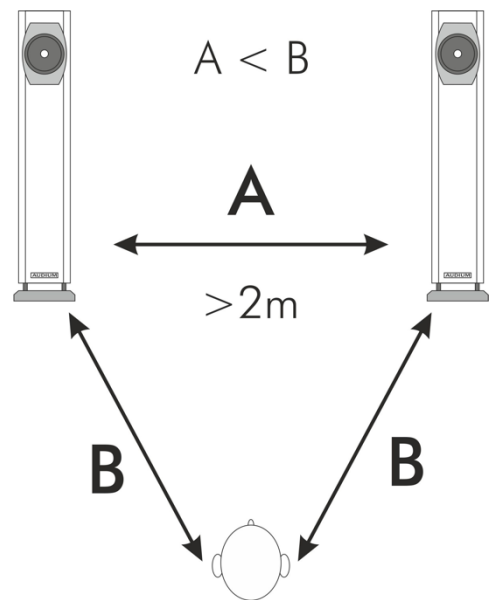

Position in your listening room

Because of physical laws, a positioning of the speaker closer as 80 cm to a wall causes an increase of the bass reproduction. So you should try to keep this as the minimum distance. By changing this distance you can adjust the bass intensity.





If this is not possible due to your room situation, you can correct this with the "Position" setting in the setup (see below). If the speaker is closer to a wall than 50 cm, select the setting "Near a wall". If the speaker is in a corner, select the "Corner" setting. You can also configure the speakers differently. E.g., if one speaker is placed near a wall, the second in a corner.

Angling

Depending on the orientation and angle of your speakers you can change the brilliance, the depth of the stage and the room reproduction.

The installation of the speakers is significant for the resulting sound.

Experiment with different settings and let your hearing judge!

	<p>An alignment of the speakers in parallel heading to your listening position ensures gentler heights.</p>
	<p>An angling of the speakers towards the listening position provides present heights / more brilliance.</p>
	<p>In many rooms, it is good to tilt the speakers backwards, ie turn the front spikes far out and the back far into it. This may result in a larger sound image with higher image.</p>
	<p>In contrast, straight alignment of the speakers will cause that the stage is more compact and more come to the forefront.</p>

Controls and Connectors

1. OLED Display: Graphics display showing the current speaker status
2. Rotary Encoder / Push Button
3. Power LED: bright red when the speaker is on, dimmed red in standby
4. Digital Input (1) coax SPDIF
5. Digital Input (2) optical mini SPDIF / TosLink – only at Master loudspeaker)
6. Digital Output (Comp7-9): connect this to the Slave Digital Input for CableLink
7. Antenna Connector – mount the Antenna here!
8. IR-Connector for optional IR receiver
9. DC Input (not shown, at lower end)
Connect the PSU plug to this socket



The *Display* shows the current speaker status, Settings and the Setup Menu.

The *Rotary Encoder* is used to make adjustments: Turning it navigates through the menu / changes values. It is also used to mute/lock the speakers.
Please see section *Muting and Locking* below.

Power Supply (PSU)

1. DC Connector
2. AC Socket
3. Power Switch (Comp 7, 8 and 9)
4. Power LED – lights green when PSU is on



Plug the DC connector into the DC socket of the loudspeaker.
Then take the Power cord, plug one end into the AC socket of the PSU, and the AC connector into a wall outlet. The PSU can handle all voltages in the range of 110-230V and 50-60 Hz.

Some PSU models also have an additional power switch.
Turn on this switch after all connections have been made.



When the PSU is on, the green power LED is lightened.

Display showing current speaker Status

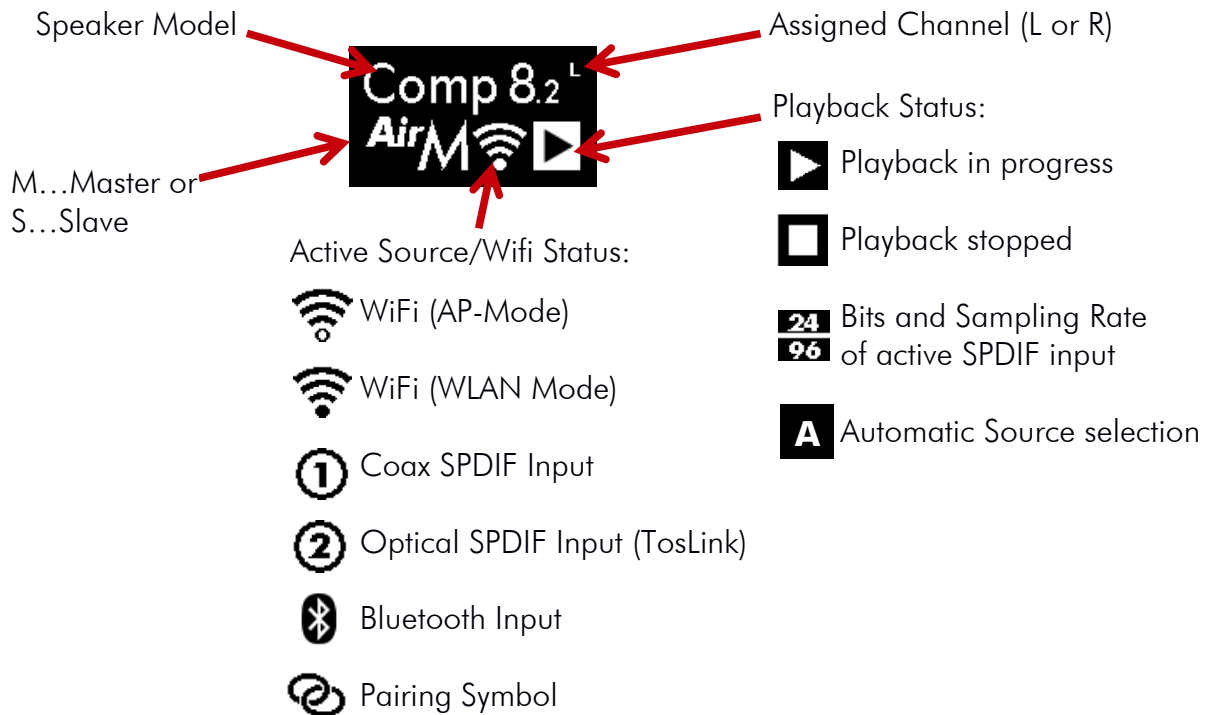
It displays the Loudspeaker Model and the current playback status of the speakers.



Examples:

 <p>Comp 8.2 Air Master. Left Channel assigned. WiFi Mode with active WiFi playback.</p>	 <p>Comp 8.2 Air Master. Left Channel assigned. Coax SPDIF active. Playback with 24 Bit / 192kHz</p>	 <p>Comp 8.2 Air Wireless Slave. Right Channel assigned. Playback (Master) active.</p>
---	---	---

Muting and Locking the Loudspeaker

Muting the speakers

Pushing the encoder while the status is shown mutes both loudspeakers (so you can turn off music quickly without the need of your Audio Source).
Pushing again will unmute the speakers immediately.

They will also be unmuted after 10 seconds (this value can be changed in the setup menu).

Locking the speakers

To lock the speakers and prevent unintended changes of the parameters, push and hold the encoder while in status view. Both speakers will be locked then (do this to prevent misconfiguration from your children!)
To unlock, push and hold the knob again.

Un-powering the loudspeakers will remove the lock.

			
Loudspeaker is muted	Mute is released	Speaker is locked	Lock is released

Auto Power On and Off

The Speakers have an integrated audio-detection circuit. If there is no playback, the loudspeaker go to standby mode after 15 minutes (you can change this in the setup menu). When music signal is detected they wake up automatically.



If you disconnect / turn off the PSUs you do not have to take care of anything. Re-powering the speakers will bring them back into the last state. All parameters (except the speaker lock and mute – see above) are stored in a non-volatile memory.

The Setup Menu

Navigation through the menu is very simple:

When you turn the encoder while the status is displayed, you will enter the setup menu. You can navigate through the menu with the encoder. If you found the setting you want to change, push it and adjust the value. Push again to confirm the value.

Sub-menus are also entered through pushing the encoder and exited through selecting “Back”.



Parameters like Auto-Off Time, Display Brightness, Language, ... will be adjusted directly on the speaker. Perform the setting always on the *Master* speaker.

Except the **Room properties, speaker position and bass setting** (which may be adjusted differing on both speakers), all parameter changes will be transmitted automatically from the master to the slave speaker. So you have to adjust them only once.

For sure you can disable this function (Menu->Air Setup->DigiLink) or adjust the parameters on the *Slave* to another value after setting the value on the *Master*.

The menu will be automatically exited after a timeout.

All Setup menu entries and their usage is shown below.

Air Wireless Speaker Pairs



The Air Wireless Speakers have a wireless digital audio link which transfers the audio being received at the master to the slave. The display shows the status of this audio-link through the Double-Ring symbol. If both are connected, it blinks at a very slow rate (every 7-8sec). Otherwise it blinks each second (e.g. when one speaker is not connected to power). In Association Mode it blinks at a high rate.

Basic Setup and connecting the Loudspeakers

If you want to connect audio sources through the digital inputs, place the *Master* close to the audio devices. Otherwise place the *Master* as close as possible to your WiFi Access-Point.

Master and Slave

The *Master* plays back the left channel by default, the *Slave* the right channel. This can be easily changed in the setup menu. The currently selected playback channel is shown by the letter L or R in the top right corner of the display.

Wireless Link or CableLink?

The Air Wireless Models do not need a cable between the *Master* and the *Slave*. Audio Data is transferred wirelessly and lossless between both speakers.

For maximum audio quality and HiRes audio playback we recommend to connect *Master* and *Slave* with the supplied SPDIF Cable (Comp 7-9). After this, you have to activate CableLink in the Setup Menu: Menu -> Air Setup -> CableLink->On

Note: The latency time reduces from 25 ms to 0 ms when using CableLink

Powering Up and Booting the Speakers

After setting up the speakers, plug the DC connector into the DC socket, at last plug the AC-plug into your wall outlet. Depending on the model of the PSU (Comp 7-9) it is equipped with a main switch, close to the AC socket. You have to turn on the PSU with this switch resulting in a green lit power LED.

The Setup should now look like this:

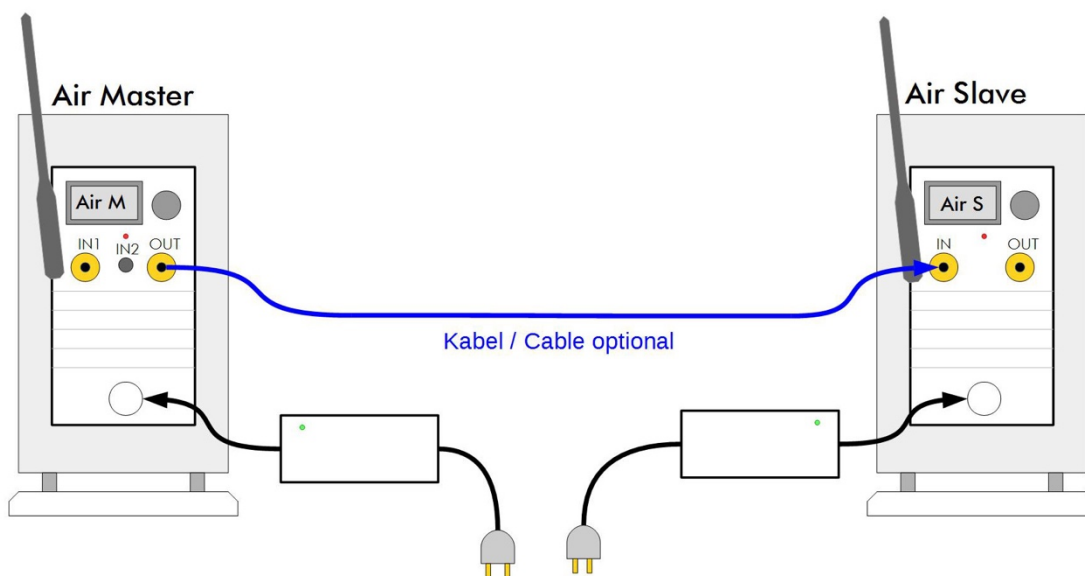

After powering up, the *Slave* is available immediately, the *Master* will take ca. 30 seconds time to boot and start the speaker and then shows the status screen.

Master:

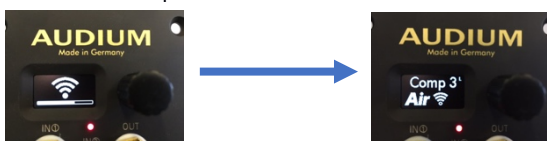

Slave:



Operating Scenarios of your Air's

There are many scenarios how to operate your Air speakers – depending on your particular demand and audio/video equipment. We want to show you three basic setups mostly found in people's living rooms:

1. As WiFi Loudspeaker in your Home with WLAN
2. As WiFi Loudspeaker to play back music through the digital inputs
3. As Bluetooth Loudspeaker connected to your Smart-TV via Bluetooth

Scenario 1: As Wifi Loudspeaker in your Home WLAN

If you want to integrate your speakers into your Home-WLAN you have to set up this scenario. It allows access to your Airs from all your home-computers, access to your NAS if you have one and use of online-streaming services.

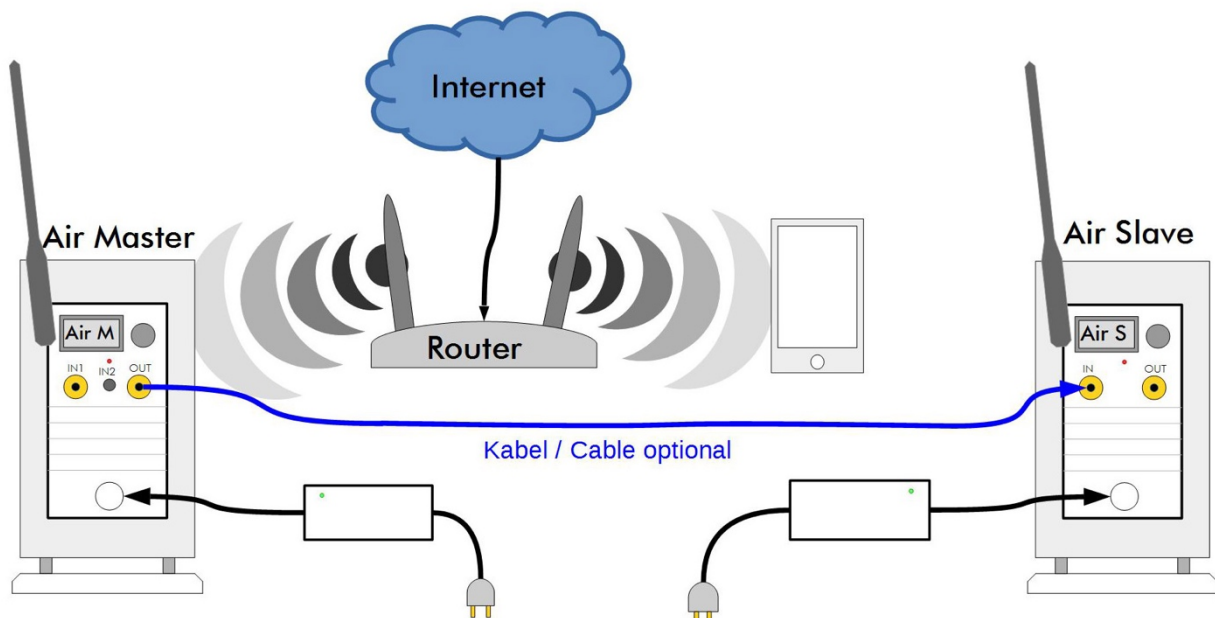

Set up your speakers and connect them to the PSUs.

Connecting the Speakers to your WLAN via the App

1. Then download and install the AUDIUMv2 App on your PC or Mac (from the www.audium.com webpage) or on your iPhone/iPad (from the App Store) or Android Phone/Tablet (from the play store).
2. Then go to network settings and select the AUDIUM-AIR-WLAN-xxxx as WLAN network.
3. Start the AUDIUMv2 App, select the Airs, get back to the first Tab, push the "WiFi >" button, select your WiFi Network, and then enter the password of your WLAN network. You can also enter a Name for your speakers as you wish.

After confirming these settings, the master speaker will reboot.

The AUDIUM-AIR-WLAN will disappear, and the Airs will join your home-WLAN.

The Antenna symbol will change from AP Mode  to WiFi  Mode

When you enter the wrong password, the speakers will fall back to AP Mode after ca 1 min. Connect your Smartphone/tablet again to the AUDIUM-AIR-WLAN and start the procedure again.

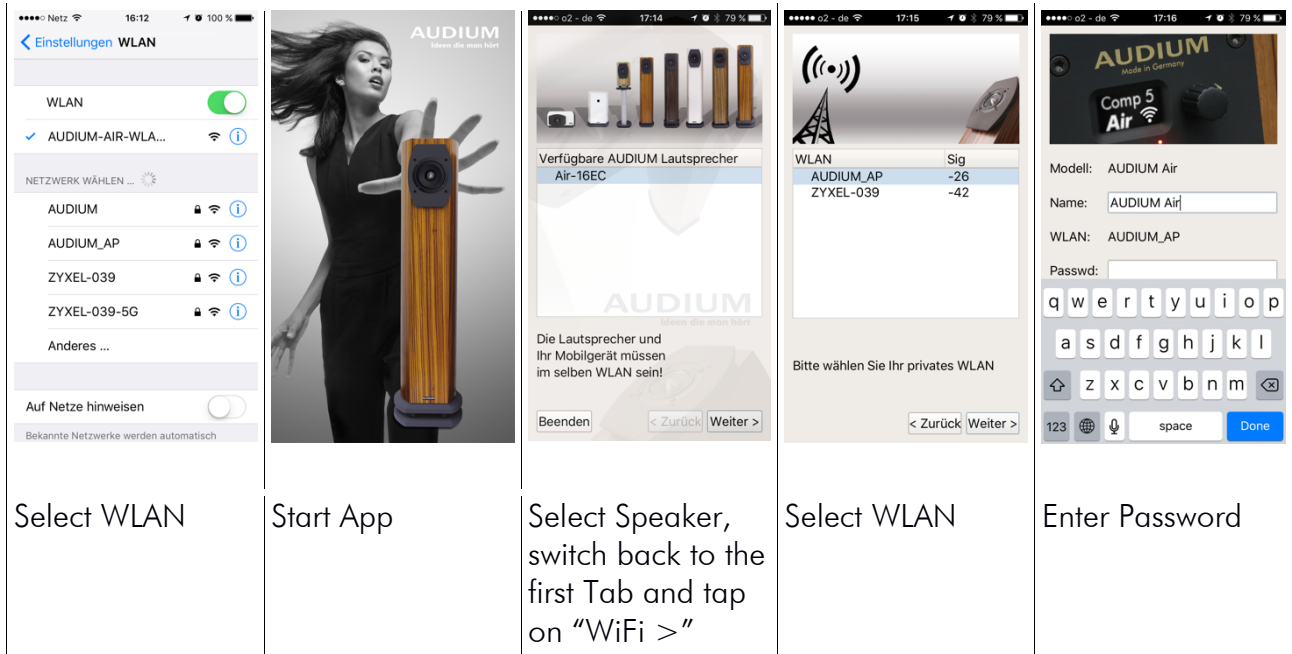

If you succeeded, you can select the Airs now as AirPlay output device and as Media Renderer from every UPnP/DLNA Application.

You can use the AUDIUM App for setting all speaker parameter! Try, it is intuitive!

Connecting the Speaker to your WLAN via WPS

You can connect your speakers to your home WLAN network through WPS, too. Therefore, at the master navigate in the menu to the WPS entry which is in the Air Setup submenu.



WAIT! Now push the WPS button of your router / WLAN access point to switch it into WPS mode, then push the encoder to activate WPS setup on the Air Master. After a short time both devices will connect, and your Air Speakers are in your home WLAN.

NOTE: Modern Routers have both 2.4G and 5G WLANs. If you perform WLAN access through this method, it is not clear whether the Air Speakers will select the 2.4G or 5G WiFi Network. This can lead to "confusions" in the data transfer between your Audio Source and the Speakers, or the AUDIUMv2 App and the speakers. To be sure which WLAN network will be selected you should use the manual method via the App.

Scenario 2: As WiFi Loudspeaker to play back music through the Digital Inputs

The Master is equipped with two digital input which allow connections of additional audio sources. Both inputs can receive digital Audio (PCM Stereo) in the range of 44.1k-192kHz and 16-24 Bit.

Input 1 is a coaxial SPDIF input with RCA/Cinch socket

Input 2 is an optical Mini TosLink socket

NOTE: Always use high quality cables for digital audio transmission. Especially when you intend to play back HiRes Audio with 24 Bit /192k! Optical SPDIF cables are often of bad quality and cause problems in audio transmission.

For easy understanding we have this possible setup:
Master is in WiFi Mode.
It has a CD-Player as audio source connected via SPDIF
And is connected to Flat TV via the TosLink input.

The Setup will then look like this:

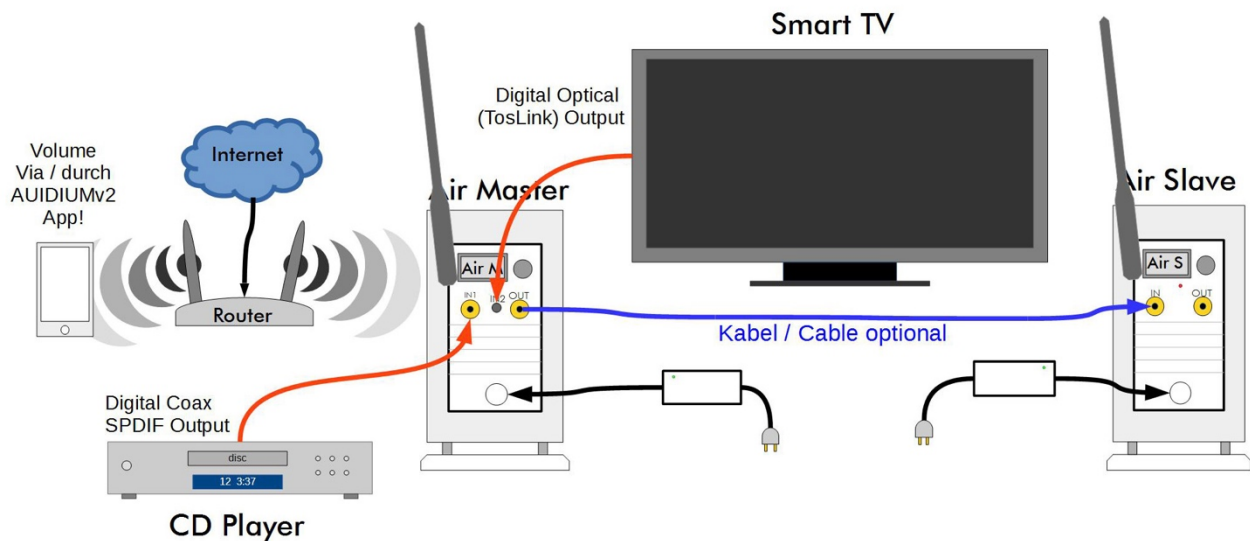

The Master has a detection circuit built inside which is constantly sensing the inputs (and the WiFi receiver as well) for audio data. If audio is detected, the inputs are selected automatically according to a priority scheme (which can be changed in the Air Setup Menu).

The default order is: Priority 1 (highest): AirPlay, Priority 2: SPDIF Input, Priority 3 (lowest): TosLink Input
In our Example: If all devices are turned off, no input is selected. If you turn on your Flat-TV, its audio data is played back. If you want to play a CD, simply turn on the CD-Player. It has a higher priority than the Flat-TV. And if you start AirPlay/DLNA playback, the Master will switch from the SPDIF input to WiFi.
You can also select the Inputs manually via the AUDIUMv2 App.

Volume Adjustment:

To adjust the volume, install the AUDIUM v2 App. You will then use this App to adjust the volume of the Airs. To use IR-Remote controls we recommend the optional IR receiver.

Scenario 3: As Bluetooth Loudspeaker for your Smart TV

The Master has a Bluetooth receiver which allows high quality audio transmission (A2DP). You can connect any device with a Bluetooth transmitter to play back audio.

One application case is to connect your Smart TV if it is equipped with a Bluetooth Sender. For first use you need to associate the Master and the TV.

Therefore select the Bluetooth input with the AUDIUMv2 App.

When doing this, the Bluetooth receiver in the Master is waiting for new connections for 1 minute. Within this time, activate the Bluetooth association on your TV to link both devices.

Then, audio from your Smart TV is sent to the AUDIUM Airs for playback.

If you set back the Input to "Automatic", the detection circuit in the Air Master will automatically switch to the Bluetooth receiver as soon as the SmartTV connects again.

NOTE ON TIME-DELAY:

The Audio-Link of Air Wireless has a latency time of 25ms for stable audio transmission.

This delay will occur between the visual content on the screen and the playback through the speakers. To get rid of this effect adjust the "Lip-Sync" Time Delay of your SmartTV to this value.

When using Comp 7, 8 or 9, activating CableLink reduces the delay to 0ms.

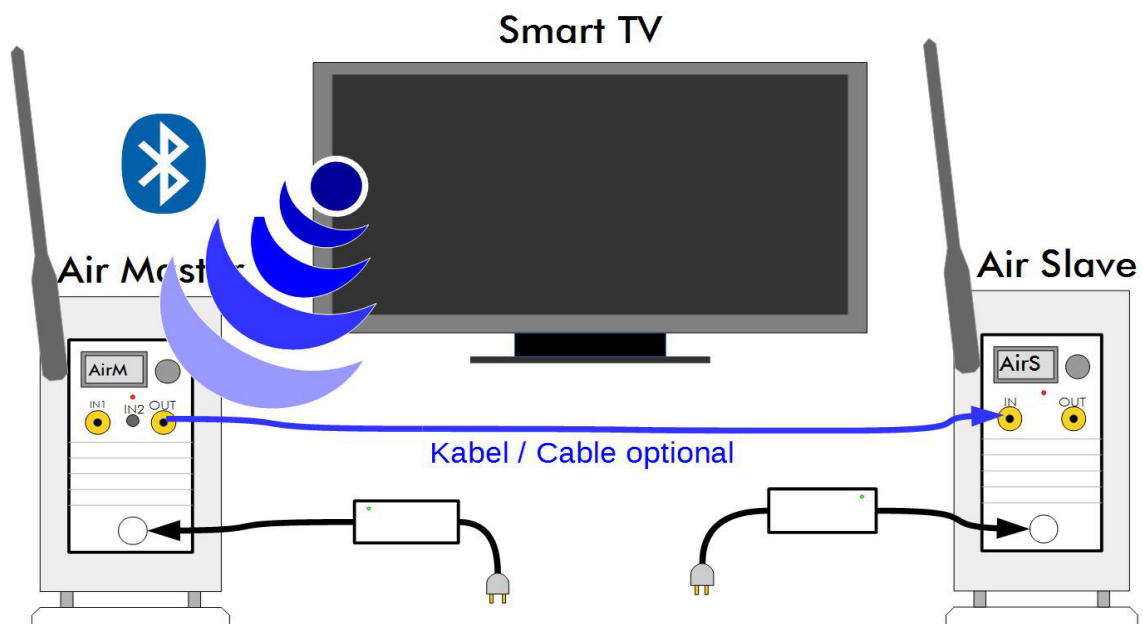

Active Inputs + Input Monitor:

„Active Input“ means, that there is signal on the input. Some devices produce signal (also silence is a signal when transferring data through SPDIF) even in Standby. So, you have to turn the device off completely through the main switch, or assign it a lower priority (see below)

You can check whether a device is detected as ON with the „Input Monitor“ in the Setup menu.
○ indicates an active Input, - indicates an inactive input.



In our example setup this would mean:
Only device which is on is the Flat-TV
CD-Player is off
No AirPlay playback

Changing the Input Priority

If you wish a different input priority scheme you can change this in the setup menu.
Enter the setup menu, then the select Air Setup, then Input Prio:



The Display shows the current Priority 1-3 setting.

Turning the encoder will cycle through all possible priority combinations. Turn it until you found the one you deserve, then push the encoder and the new order will be saved.

NOTE! If a device causes an active input at the Master, it may not go to standby as long as you leave this device on / in standby. Turn it off through the main switch, and the Airs will go to standby also.

Advanced Speaker Setup and Adjustments

Perfect speaker placement in a perfect listening room is often very far away from what can be achieved in reality. Not only that a „normal“ listening room is not perfect in terms of its size, shape and reverb behaviour – it often happens that the conditions for the left speaker are differing to the conditions of the right speaker! E.g. the left one is placed in a corner, whereas the right one is close to a wall. Physics that stands behind our environment, being a major concern for the quality of reproduction of music cannot be turned off unfortunately. Nor can it be completely compensated by modern computing algorithms or technology. But at least we can reduce its impact and compensate it to some amount!

AUDIUM Air speakers are constructed in a way that makes them less depending on the environment where they are placed. And they allow an exact prediction of the audio reproduction in the contexts of different listening rooms. This allows us a compensation of these physical effects through the DSP (digital signal processor) which is built into each speaker.

Three Parameters allow an adaptation of the *Airs* to the listening room: Speaker Position, Room Properties and Bass decrease / increase.

Speaker Position

Placement of a loudspeaker in a room's corner results in an increased level of bass reproduction, compared to placement free in a room with least bass level (distance to walls > 0.5m).

At your AUDIUM Air Speakers you can choose between 3 speaker positions:

Free Placement, Close to a wall (or on a sideboard at Comp3), or in a corner.

Adjust this setting according to the placement of your speaker and you will have optimum bass reproduction. You can choose different settings for both speakers!

Room Properties

Each room sounds different. One is very „dumb“, the other one is very clear, or harsh. It depends mostly on the room furniture. Since you unfortunately would not change your living room's interior because you bought new AUDIUM loudspeakers, we do it the other way round. We adjust the speakers to your room! 5 Steps are possible:

1. Strongly Dampened Room: Lots of furniture, heavy rugs and thick curtains
2. Dampened Room: A bit less..
3. Normal Room: „Normal“ furniture
4. Reverb Room: A bit more then...
5. Strong Reverb Room: Few furniture, Stone floor, big glass windows, no curtains









If it is hard for you to select the appropriate setting, simply start listening music in the „Normal“ setting. If you think music is not bright/clear enough, select „Dampened Room“. If music is too harsh, select „Room with reverb“.

Bass Setting

With this parameter you can decrease or increase deep bass reproduction. Changes here will apply to a frequency spectrum that is less audible, but more „feelable“. So you can make music playback more a body experience. Take care to not increase this setting too much since it may also cause an increase of room resonances which cause an undefined and spongy bass reproduction.



Appendix 1: Main Setup Menu





The following Table shows all menu entries available in the main menu of Master and Slave. The “Link Column” indicates whether a change of this parameter at the Master is automatically transferred to the Slave speaker. The letter in the last column (M / S) indicates whether this menu entry is available at the Master or at the Slave, or both.

Icon	Menu	Description	Comment	Link	M / S
	Bass	Sets Bass Parameter	-1 reduces, +1 and +2 increase deep bass reproduction	N	MS
	Position	Sets Loudspeaker Position	Adjust between free placement, placement near a wall, or placement in a corner	N	MS
	Room	Sets properties of your listening room.	Set to reverb when your room is empty, set to dampened when you have much furniture/curtains	N	MS
	Setup Gains	Goto Sub-menu for setting the gain of the inputs			M
	EQ 1	Parametric EQ for bass		-	MS
	EQ 2	Parametric EQ for treble		-	MS
	Setup	Go to Sub-menu of advanced speaker parameters		-	MS
	Setup Air	Go to Sub-menu of Air parameters		-	MS
	Exit	Exit the menu.		-	MS

Advanced Setup Menu (identical at Master and Servant)









More settings concerning the speaker.

Icon	Menu	Description	Comment	Link
	Auto Off	Set time after which speakers will go to standby if no input is active	Default value 15 minutes.	Y
	Mute Time	Set the time the speaker will remain muted when you push the knob during status display.	Default value 10sec	Y
	Display Brightness	Sets the brightness of the display	Default is 5 (maximum)	Y





	Display Dim Time	Set time after which the display will be dimmed to darkness.	Default: display will be never dimmed (the lying 8 stands for infinite)	Y
	Language	Change the language of the display messages		Y
	Factory Reset	Bring back the speaker to factory defaults.	WiFi Settings will not be change	-
	Info	Show Information about this speaker		-
	Exit	Exit the Submenu		-

Air Setup Menu (at Master Loudspeaker)

Settings concerning the WiFi Link of the Master loudspeaker.





Icon	Menu	Description	Comment	Link
	WPS Setup	Enable WPS Setup Mode	Also press WPS on your Router to connect WiFi	-
	Pairing	Enable Pairing Mode	For Pairing Master and Slave	-
	Cable Link	Turn on SPDIF output for master and slave link via cable	Only necessary when using the SPDIF cable for HiRes Playback.	-
	Channel	Assigns left or right channel to the speaker	The Slave Speaker will be automatically assigned to the opposite channel.	Y
	Input Monitor	Shows which Input is detected as active		
	Input Priority	Change the priority for automatically selecting the inputs		-
	Reset	Reset the WiFi receiver	Speaker Settings (Bass, Position, ...) remain unchanged	-
	Exit	Exit the Sub-menu		-

Air Setup Menu (at Slave Loudspeaker)

Icon	Menu	Description	Comment	Link
	Pairing	Enable Pairing Mode	For Pairing Master and Slave	-
	Channel	Assigns left or right channel to the speaker	The Slave Speaker will be automatically assigned to the opposite channel of the Master.	-
	Digi Link	If ON, changes of parameters at the master affecting both speakers are automatically received to the Slave	Bass and Position are excluded.	-
	Exit	Exit the Sub-menu		-

Gain Menu (only at Master Loudspeaker)





Sometimes the volume level of digital sources are varying in a high degree. So changing the source at the *Master* may cause big differences in playback volume. In this menu you can adjust the playback volume of the WiFi Receiver and the digital inputs in an appropriate way.

Icon	Menu	Description	Comment	Link
	Gain Total	Set overall speaker playback volume	0dB default. -6dB is half volume, +6db double.	Y
	Gain WiFi	Gain of WiFi and Bluetooth		
	Gain (1)	Gain of SPDIF Input		
	Gain (2)	Gain of Toslink		

EQ menu

At AUDIUM **Air** loudspeakers you can configure two EQs (aka parametric equalizer) to lower or raise frequency bands.

This makes it possible to increase or decrease a frequency band.
It can be used to correct drone frequencies or room resonances.

Symbol	Menu	Description	Comment
 EQ	EQ On/Off	Turn the EQ on or off.	
 f_s	Frequency	Set the center frequency here.	Values between 20 Hz and 200 Hz are possible
 GAIN	Gain	Set the height of the EQ here	Values between -24 and +6 dB are possible
 Güte Q	Quality	Set the quality of the EQ here.	Values between 1 and 10 are possible

The frequency determines the position of the filter, the gain of the filter and the quality the width of the EQ.
The graphic on the right shows different settings of the EQ.

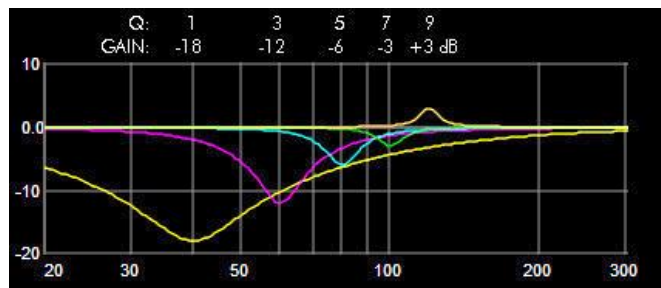

of
The

Appendix 2: Hints for setting up your WiFi

1. Since the transfer of audio data is done performed wireless, it is subject to distortions from the surround. It is hard to reach a 100% stable audio-transmission. But to gather ideal results while having this big number of WLANs in cities it is recommended to check the Points listed below.
2. Always use High Quality Routers and WiFi-Accesspoints. Good routers provide QoS and Bandwidth-management and assign higher priority to audio data then bulk data. (WMM = Wi-Fi Multimedia [https://de.wikipedia.org/wiki/Wi-Fi_Multimedia]).
Allways have a look whether the firmware of your Router is in the newest version!
3. Check the number of WiFi Networks in the 2.4G and 5G Band and chose you Wifi from the Band with less existing networks..
4. The AUDIUMv2 App shows the signal strength to the WiFi Accesspoint.
As much as possible, place the AUDIUM Air Master as close to your WiFi Router as possible. The App then shows a higher value. You can then assign left and right channel to the speakers in the Setup meny if you had to exchange them.
5. A general rule is: as smaller the distances between Sender (Smart-Phone, Laptop, ...), Receiver (Air Master) and your Router/WiFi Access point, as higher the transfer stability.
6. Some Routers show WiFi Channel assignments and signal stength. Have a look there and choose a channel that is least used of all. If possible, deactivate this monitoring feature again.
7. MacOS also supplies good tools: Hold Alt+ click on WLAN Symbol => open Diagnose => Scan => lists a report with recommended free channel.
2.4G has 13 Channels. 9+10 are used by Microwave ovens, 1, 6 and 11 do not overlap. If there is another router close to you, chose a channel with +/-3 [http://praxistipps.chip.de/wlan-einrichten-welchen-kanal-waehlen_34273]
8. Deactivate „Search for WLANs“ feature in WiFi devices
9. If you play back Music from a mobile device, try to keep the distance between it and the WiFi Access Point as short as possible.
10. Have a look at the Signal/Transfer-Quality under MacOS (WiFi Diagnose). There you can watch for bad signal quality and distortions in your channel.
11. The Antenna of your Router and AIR Master has a sensitivity similar to a Doughnut. If possible, keep the antennas in an upright position without any obstacle in-between.
12. Use a separate WLAN (ideally with separate WiFi Router) on a unique Channel only for the Audio transfer.

Appendix 3: Glossary

Access Point	„Base Station“ for wireless transmission. Gives access to your wireless LAN. Abbreviated as AP. Often included in a Router.
AP Mode	„Access Point Mode“ - your Air Master Speaker builds a WLAN on its own. No Access Pointer / Router necessary.
AirPlay	Wireless Audio Transmission, developed by Apple Inc.
AUDIUMv2 App	The APP to configure your Airs for your home WLAN
Detection circuit	Electronics that detects audio signal
Digital Amplifier	Electronics to amplify music digitally with high efficiency. Low heat production, low space.
DLNA	Digital Living Network Alliance (similar to UPnP) – a standard to stream music over a LAN
DSP	Digital Signal Processor – a computer processor optimised for calculations on digital audio signals
Input Priority	Priority of an audio input at the Air Master speaker
LAN	Local Area Network – cable based local network infrastructure
Master Speaker	The Speaker with the WLAN/WiFi Receiver and coax. SPDIF and Toslink input connector.
Priority Scheme	Assignment of priorities to the inputs
PSU	Power Supply Unit
Router	Device that connects your LAN to the Internet. Often has a Access-Point built inside.
Slave Speaker	The Speaker which has only a single digital in- and output
SPDIF	Sony/Philips Digital Interface: a customer standard for transmission of digital audio signals over a cable
TosLink	Toshiba Link (or optical SPDIF): a customer standard for transmission of digital audio signals via fiber-optics, designed by Toshiba.
UPnP	Universal Plug and Play (similar to DLNA) – a standard to stream music over a LAN
WiFi / WLAN	Wireless LAN – wireless network infrastructure
WiFi Mode	Your Air Master speaker is connected to an existing WLAN.

Appendix 4: Questions and Answers

Q: I connected the Power Supply, but the speaker does not turn on.

A: In case of a Comp 7, 8 or Comp 9 your power supply may have a main switch. Please check whether this switch is turned on.

Q: I want to access the speakers through AirPlay but I get the message „Device already in use“

A: You have to disconnect an active AirPlay Source before you can access the speakers through another source.

Q: The volume is jumping when I adjust it.

A: Check whether you are playing via AirPlay and another UPnP/DLNA App is open in the background. They will compete and confuse the volume setting

Q: I wanted to configure the Airs with the AUDIUM App for my home-WiFi, but they always switch back to AP-Mode.

A: Probably you entered the wrong password. Reconfigure the speakers with the AUDIUM App.

Q: I have interruptions while I am playing back music wirelessly. What can I do?

A: Check the hints for setting up and configuring your Home WiFi.

Q: The loudspeakers do not turn off automatically any more!

A: Check whether one of the inputs is detected as active. Use the "Input Monitor" therefore

A: Check the auto-off Time.

Q: The Master plays music, but the Slave does not play any sound

A: Did you connect the speakers with the included SPDIF cable?

A: Check that you connected the cable to Air/Master:Out and Digi/Slave:In connectors

Q: I have an android phone and want to play back music. How can I do this?

A: Download Bubble-UPnP from the PlayStore

A: Download AnyCast from the PlayStore

Q: I connected my Settop-Box or Flat-TV to the Air-Master.

It gets selected as input, but I do not hear any sound.

A: Maybe this source outputs Multichannel encoded audio-data. Go to the setup of the device and select Stereo-PCM output.

Q: I turned up the volume to the maximum, but my Air's are not playing loud enough!

A: Increase the GAIN-Value into the setup to +3dB or +6dB

Appendix 5: Technical Data

Property	Comp 3	Comp 5	Comp 7	Comp 8	Comp 9
Fullrange Ø	76mm (3")	76mm (3")	76mm (3")	100mm (4")	100mm (4")
Woofers Ø	150x230mm (6x9")	150x230mm (6x9")	150x230mm (6x9")	220mm (9")	270mm (11")
PSU	150W	150W	200W	200W	200W
Max Power Fullrange	30W	30W	30W	50W	50W
Max Power Woofer	100W	100W	100W	130W	130W
Coax SPDIF	16-24 Bit 44.1-192kHz				
Optical SPDIF	16-24 Bit 44.1-192kHz				
Dimensions	215 x 350 x 290 mm	215 x 920 x 290 mm	215 x 940 x 290 mm	250 x 1020 x 340 mm	270 x 1060 x 360 mm
Weight	8.5kg	17kg	18kg	25kg	29kg

Appendix 6: Disclaimer

iPhone, iPad, iPod, MacBook, MacBookPro, AirPlay are trademarks of Apple Inc.
DLNA are trademarks of Digital Living Network Alliance.



This Manual can be subject to change without notice.

You can download the newest version on www.audium.com/downloads.

E.C. MARKING:

E.C. marking certified the conformity with low tension directive
73/23/CEE, directive CEM 89/336/CEE and national transpositions.



Proper Disposal of Products

The label printed on the device indicates that the product must not be deposited
in the normal waste bin. Hand it back to your dealer or any other institution
capable of proper deposition of electronic devices.



The AUDIUM WEEE Registration number is DE 83106685

Version 2.0 – 28.7.2020